

***Yolin***

**Electric Bike Display**

# **User's Manual**

**YL91F-V**

**Tianjin Yolin Technology Co. Ltd.**

## TABLE OF CONTENTS

1. PRODUCT NAME AND MODEL NUMBER .....	1
2. SPECIFICATION .....	1
3. APPEARANCE AND SIZE .....	1
4. FUNCTION OVERVIEW AND FUNCTIONAL AREAS .....	3
4.1 FUNCTIONAL OVERVIEW .....	3
4.2 FUNCTIONAL AREAS .....	3
4.3 BUTTON DEFINITIONS .....	3
5. ROUTINE OPERATION .....	3
5.1 POWER ON/OFF .....	3
5.2 DISPLAY INTERFACE SWITCHING .....	4
5.3 WALK BOOST MODE .....	5
5.4 TURNING ON/OFF LIGHTS .....	5
5.5 PAS LEVEL SELECTION .....	5
5.6 BATTERY LEVEL DISPLAY .....	6
5.7 ERROR CODE DISPLAY .....	6
6. PERSONALIZED PARAMETER SETTINGS .....	6
6.1 METRIC AND IMPERIAL SETTING .....	7
6.2 RATED VOLTAGE SETTING .....	7
6.3 PAS LEVEL SETTING .....	8
6.4 WHEEL DIAMETER SETTING .....	8
6.5 NUMBER OF SPEED SENSOR MAGNETS SETTING .....	9
6.6 SPEED LIMIT SETTING .....	9
6.7 START-UP SETTING .....	10
6.8 DRIVE MODE SETTING .....	10
6.9 PEDAL ASSIST SENSITIVITY SETTING .....	11
6.10 PEDAL ASSIST STRENGTH SETTING .....	11
6.11 NUMBER OF PEDAL ASSIST SENSOR MAGNETS SETTING .....	12
6.12 CONTROLLER CURRENT LIMIT SETTING .....	12
6.13 BATTERY UNDER VOLTAGE VALUE SETTING .....	13
6.14 POWER-ON PASSWORD SETTING .....	13
6.15 AUTO SLEEP TIME SETTING .....	14
7. SHORTCUT OPERATION .....	15
7.1 SHORTCUT OPERATION .....	14
7.2 TRIP ODOMETER RESET OPERATION .....	14
8. QUALITY ASSURANCE AND WARRANTY .....	16
8.1 WARRANTY INFO .....	16
8.2 WARRANTY DOES NOT COVER .....	16

9. WIRE CONNECTION DIAGRAM ..... 16

    9.1 STANDARD WIRE CONNECTION SEQUENCE ..... 16

10. PRECAUTIONS ..... 16

SCHEDULE 1: ERROR CODE DEFINITION ..... 17

SCHEDULE 2: PEDAL ASSIST LEVEL DEFAULT RATIO VALUE ..... 17

### 1. Product Name and Model Number

Smart LCD display for electric bicycle; Model: YL91F-V.

### 2. Specification

- 36V/48V/52V power supply
- Display rated current 15mA
- Display maximum current 30mA
- Shutdown leakage current <1uA
- Supplied current to the controller 50mA
- Operating temperature -20~60°C
- Storage temperature -30 to 70° C

### 3. Appearance and Size



Figure 3-1 Physical picture of the YL91F-V display



Figure 3-2 Physical picture of the K5 control button



Figure 3-3 Physical picture of the K6 control button

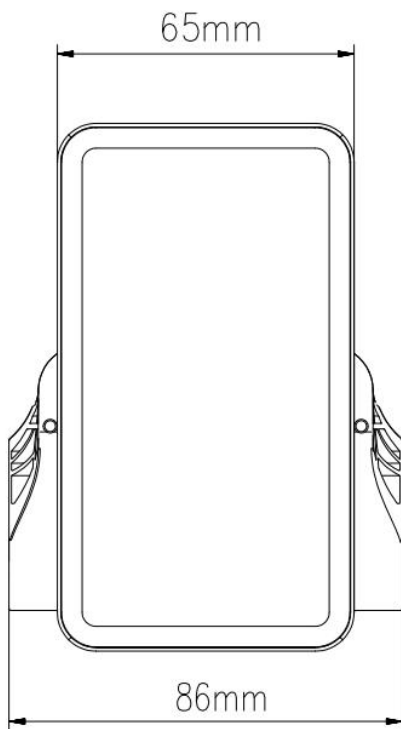

Figure 3-4 91F-V Front View Dimension

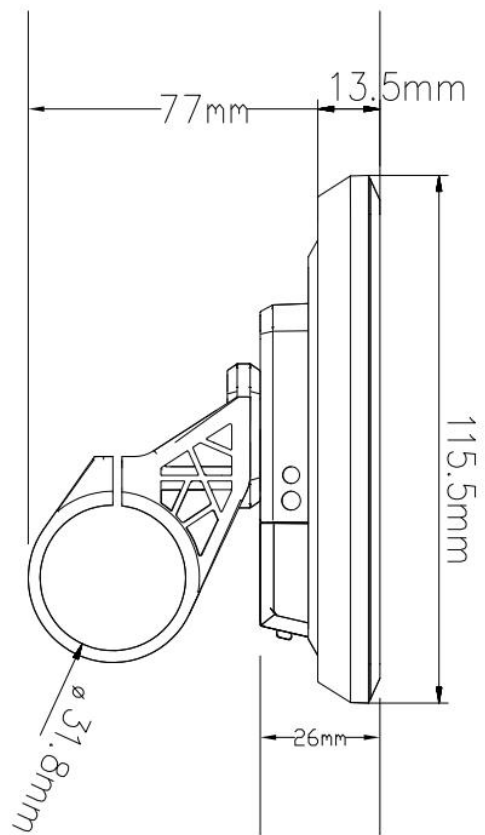

Figure 3-5 91F-V Side View Dimension

## 4. Function overview and Functional areas

### 4.1 Functional overview

The YL91F-V display offers a variety of features to suit your riding needs, including:

- Battery level indicator
- Pedal assist (PAS) level indicator
- Speed (current speed, maximum speed, average speed)
- Mileage display (single and total mileage)
- Walk boost mode
- Light ON/OFF
- Error code indicator
- Motor power indicator (optional)
- USB connection indicator (optional)
- Cruise control indicator (optional)
- Bluetooth connection indicator (optional)
- Personalized parameter settings (e.g. wheel diameter, speed limit, battery power setting and PAS parameter setting, password setting, controller current limit setting, etc.).
- Factory default parameter recovery function

### 4.2 Functional areas

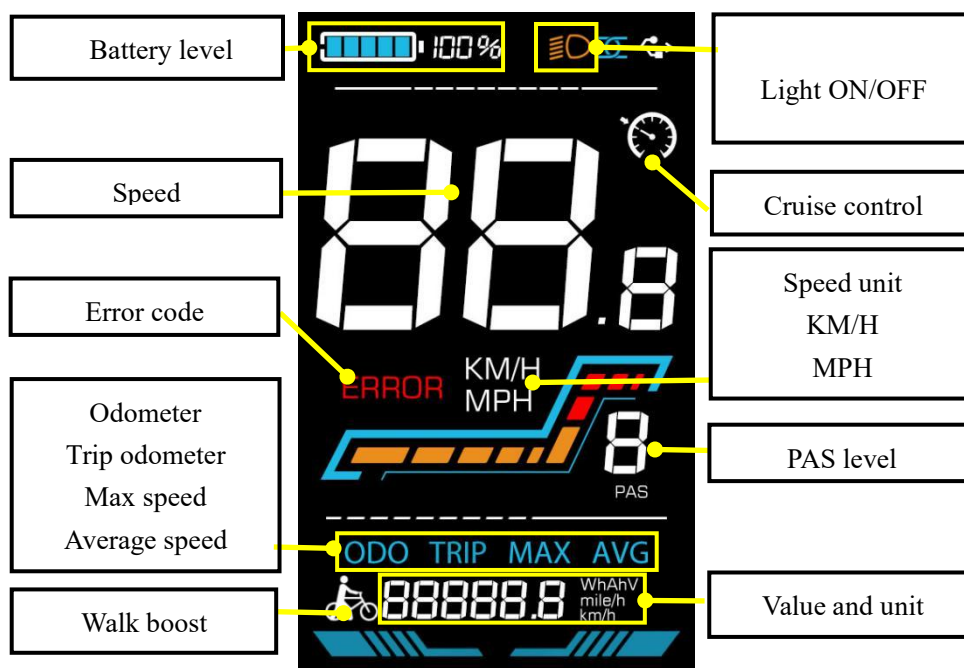







Figure 4-1 YL91F-V functional area distribution interface

### 4.3 Button definitions

The YL91F-V display is equipped with five buttons on the corresponding operating unit: power on/off , plus , minus , light  and toggle .

## 5. Routine operation

### 5.1 Power on/off

Long press  to power on/off the display. When the display is off, it will not use the battery power and the leakage current is less than 1uA.

⚠ The display will automatically shut off if it is not used for more than 10 minutes.

### 5.2 Display interface switching

When the display is powered on, it will show the Current Speed (km/h) and Odometer (km) by default. Short press

**i** to switch between Odometer (km), Trip Odometer(km), Maximum Speed (km/h), and Average Speed (km/h).

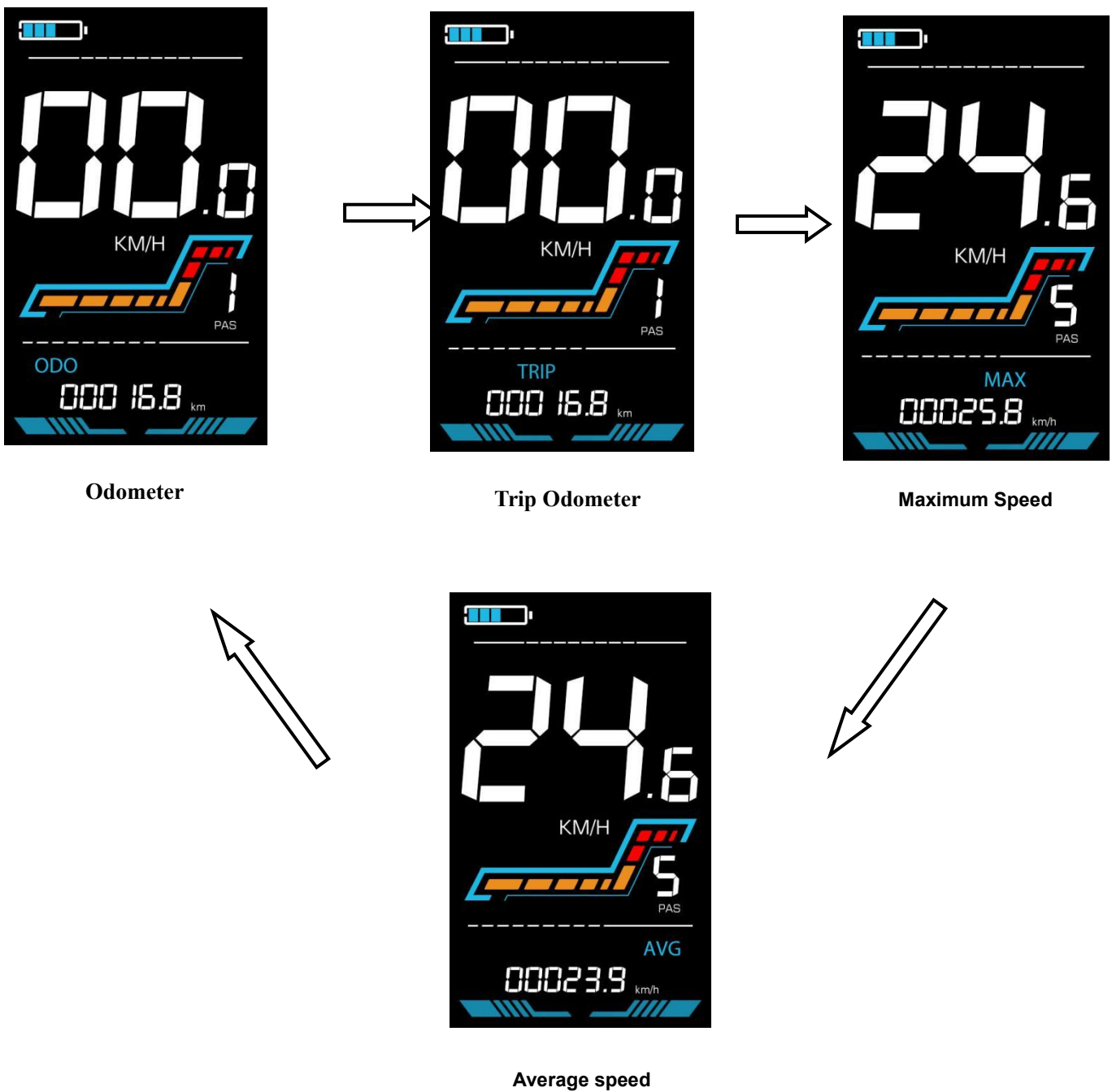

Figure 5-1 Display Interface Switching

### 5.3 Walk boost mode



Long Press and hold , the electric bicycle enters the walk boost mode. The electric bicycle will walk at a fixed speed of 6 km per hour and the display shows . Release the button to stop the power output immediately and restore to the state before walk boost.



Figure 5-2 Helping to implement the display screen

**⚠** The walk boost mode can only be used when pushing the electric bicycle, please do not use it while riding.

### 5.4 Turning on/off lights



Press the  to make the controller turn on the lights and the display backlight becomes dim. Press  again to make the controller turn off the lights and the backlight restore brightness.



Figure 5-3 Backlight display interface

### 5.5 PAS level selection



Press  /  to switch PAS level of electric bicycle, thus changing the motor output power.





Figure 5-4 PAS level display interface

**5.6 Battery level display**

The Battery level is shown as 5 bars. When the battery is full charged, all of the 5 bars lighten up. When the battery is fully depleted, the bar will begin to flash, warning the user to charge the battery as soon as possible.

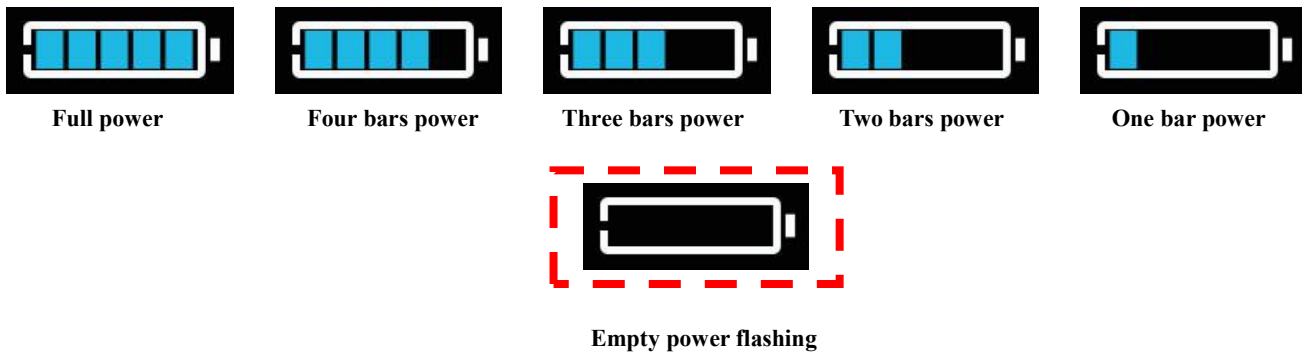

Figure 5-5 Battery Level Display Interface

**5.7 Error code display**

If there is a fault occurs in the electronic system of the electric bicycle, the display will automatically show an error code, see Schedule 1 for a detailed definition of the error code.

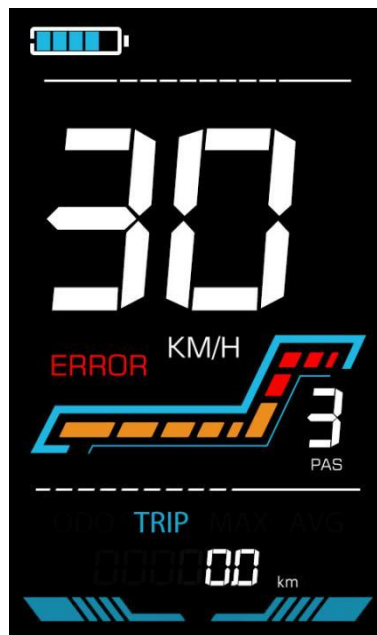

Figure 5-6 Error Code Display

**⚠** When the error code appears on the display, please troubleshoot the problem in time, the electric bicycle will not be able to drive normally after the problem occurs.

**6. Personalized parameter settings**

**⚠** Each setting needs to be done with the bicycle stationary.

The personalized parameter setting procedure is as follows:

When the display is ON and the speed shows 0,

- (1) Press and hold **+** **-** simultaneously for more than 2 seconds to enter the personalized parameter setting interface.
- (2) Press **+** / **-** to toggle between the personalized parameter setting interface, and press **i** to enter the parameter changing state.
- (3) Press **+** / **-** to select the parameter, long pres **+** for addition operation, long press **-** for subtraction operation.
- (4) Press **i** to save the parameter settings and return to the personalized parameter setting interface.
- (5) Long Press **i** to save the parameter settings and exit the personalized parameter setting interface.

The following options are available on the personalized parameter setting interface:

### 6.1 Metric and Imperial setting

P1 is the metric and imperial setting, 00 for metric and 01 for imperial.

Press **i** to enter the parameter changing state. Press the **+** / **-** to select the parameter and press **i** to save the parameter setting and return to the personalized parameter setting interface.

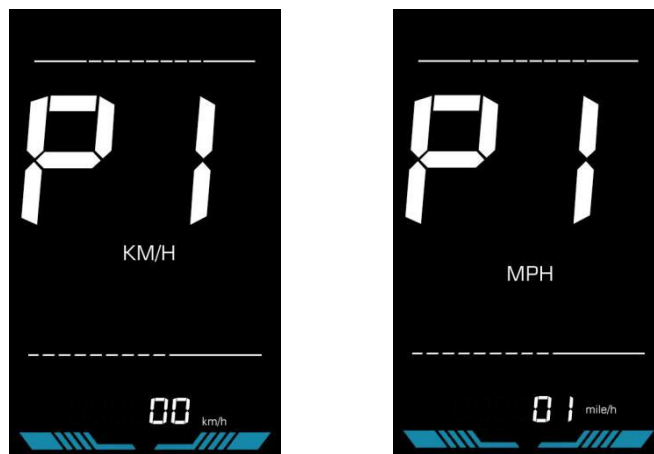

Figure 6-1 Metric and Imperial Units Setting Interface

### 6.2 Rated voltage setting

P2 is the rated voltage setting. The available rated voltage range is: 24V, 36V, 48V, 52V.

Press **i** to enter the parameter changing state. Press the **+** / **-** to select the parameter and press **i** to save the parameter setting and return to the personalized parameter setting interface.



Figure 6-2 Rated voltage setting interface

### 6.3 PAS level setting

P3 is the Pedal assist (PAS) level setting. The available Pedal assist level settings are: 0~3, 1~3, 0~5, 1~5, 1~7, 0~7, 0~9, 1~9.

Press **i** to enter the parameter changing state. Press the **+**/**-** to select the parameter and press **i** to save the parameter setting and return to the personalized parameter setting interface.

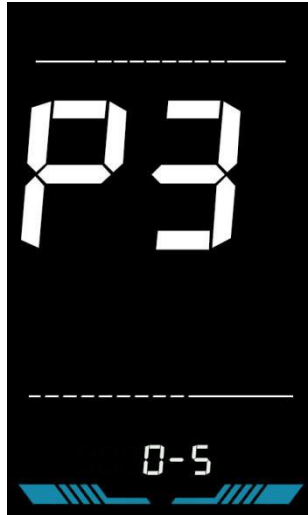

Figure 6-3 PAS level setting interface

### 6.4 Wheel diameter setting

P4 is the wheel diameter setting. The adjustable wheel diameter range is: 1~50inch.

Press **i** to enter the parameter changing state. Press the **+**/**-** to select the parameter and press **i** to save the parameter setting and return to the personalized parameter setting interface.



Figure 6-4 Wheel diameter setting interface

### 6.5 Number of speed sensor magnets setting

P5 is the speed sensor magnet number setting. The adjustable speed sensor magnet number range is: 1 ~ 100 pcs.

Press **i** to enter the parameter changing state. Press the **+**/**-** to select the parameter and press **i** to save the parameter setting and return to the personalized parameter setting interface.



Figure 6-5 Number of speed sensor magnets setting interface

### 6.6 Speed Limit Setting

P6 is the speed limit setting. The adjustable speed limit range is: 1~100km/h. (The maximum adjustable speed limit varies by different protocols)

Press **i** to enter the parameter changing state. Press the **+**/**-** to select the parameter and press **i** to save the parameter setting and return to the personalized parameter setting interface.



Figure 6-6 Speed limit setting interface

## 6.7 Start-up setting

P7 is the start-up setting. The display can choose the following start modes: 00→zero start, 01→non-zero start.

Press **i** to enter the parameter changing state. Press the **+**/**-** to select the parameter and press **i** to save the parameter setting and return to the personalized parameter setting interface.



Figure 6-7 Start-up setting interface

## 6.8 Drive mode setting

P8 is the drive mode setting. The available drive modes are: 00→Pedal assist only, 01→Electric only, 02→Both Pedal assist and electric.

Press **i** to enter the parameter changing state. Press the **+**/**-** to select the parameter and press **i** to save the parameter setting and return to the personalized parameter setting interface.



Figure 6-8 Drive mode setting interface

### 6.9 Pedal assist sensitivity setting

P9 is the pedal assist sensitivity setting. When set to higher numbers, it will take more crank rotations to activate the motor. On lower numbers, it will take little crank rotation to activate the motor. The adjustable range is: 1~24.

Press **i** to enter the parameter changing state. Press the **+**/**-** to select the parameter and press **i** to save the parameter setting and return to the personalized parameter setting interface.



Figure 6-9 Pedal assist sensitivity setting interface

### 6.10 Pedal assist strength setting

PA is the Pedal assist strength setting. The Pedal assist strength is the relative strength of the PWM signal from the controller when start to activate pedal assist. The adjustable range is 0 ~ 5. 0 is the weakest strength and 5 is the strongest.

Press **i** to enter the parameter changing state. Press the **+**/**-** to select the parameter and press **i** to save the parameter setting and return to the personalized parameter setting interface.



Figure 6-10 Pedal assist Start-up intensity setting interface

### 6.11 Number of pedal assist sensor magnets setting

Pb is the number of pedal assist sensor magnets setting. The adjustable range: 1~15 pcs.

Press **i** to enter the parameter changing state. Press the **+**/**-** to select the parameter and press **i** to save the parameter setting and return to the personalized parameter setting interface.



Figure 6-11 Number of pedal assist sensor magnets setting interface

### 6.12 Controller Current Limit Setting

PC is the controller current limit setting. The adjustable range is: 1~50A.

Press **i** to enter the parameter changing state. Press the **+**/**-** to select the parameter and press **i** to save the parameter setting and return to the personalized parameter setting interface.



Figure 6-12 Controller current limit setting interface

### 6.13 Battery under voltage value setting

Pd is the battery under voltage setting. The value can be adjusted based on the current rated voltage.

Press **i** to enter the parameter changing state. Press the **+** / **-** to select the parameter and press **i** to save the parameter setting and return to the personalized parameter setting interface.

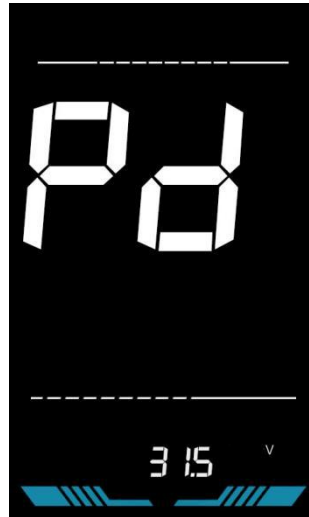

Figure 6-13 Battery under voltage value setting interface

### 6.14 Power-on password setting

PE is the power-on password setting. The power-on password is not activated by default but users can activate it from setting PSd-y. The factory default password is 1212. Users can set other four-digit password. Please keep the password in mind after changing it, otherwise you will not be able to use the display.

Press **i** to enter the parameter changing state. Press the **+** / **-** to select the parameter. PSd-y means the power-on password is activated while PSd-n is off. Press **i** to confirm the mode and enter the state of setting the four digits power-on password or exit to the personalized parameter setting interface.



Figure 6-14 Power-on Password OFF interface



Figure 6-15 Power-on Password Activated interface



In the password setting mode, the adjustable digit will flash. Press the **+** / **-** to select the parameter and press **i** to save the numbers and go to the next digit setting. Long press **i** to save the parameter setting and return to the personalized parameter setting interface after finish setting the four digits in turn.



Figure 6-16 Power-on password setting interface

### 6.15 Auto Sleep Time Setting

PF is the auto sleep time setting. To save the battery power and reach higher range, this display will be turned off after it has not been used for a time. The adjustable range is: 1~60min, 00 means no auto shutdown. The factory default setting is 10 minutes.

Press **i** to enter the parameter changing state. Press the **+** / **-** to select the parameter and press **i** to save the parameter setting and return to the personalized parameter setting interface.



Figure 6-17 Auto Power Off Time Setting Interface

## 7. Shortcut operation

### 7.1 Restore factory settings operation

dEF is the restore factory default parameter settings. dEF-Y is to restore the factory default settings, and dEF-N is not to restore.







Enter into the main setting interface and keep the speed at 0, press and hold  and  simultaneously for 2s to enter the restore factory default setting interface. Pressing  /  to toggle to dEF-Y. Then after pressing  to confirm, the display will show dEF-0 for a few seconds and then automatically start to restore the factory default settings. The display will automatically exit to setting interface after the restoration.



Figure 7-1 Restore Factory Default Settings Interface

### 7.2 Trip odometer reset operation

The display can record trip odometer and odometer. Trip odometer is not automatically reset after turning off. The trip odometer needs to be reset manually. The odometer can not be reset.

Enter into the main setting interface and keep the speed at 0, press and hold  and  simultaneously for 2s to reset the trip odometer. The main interface will flash during the reset process.

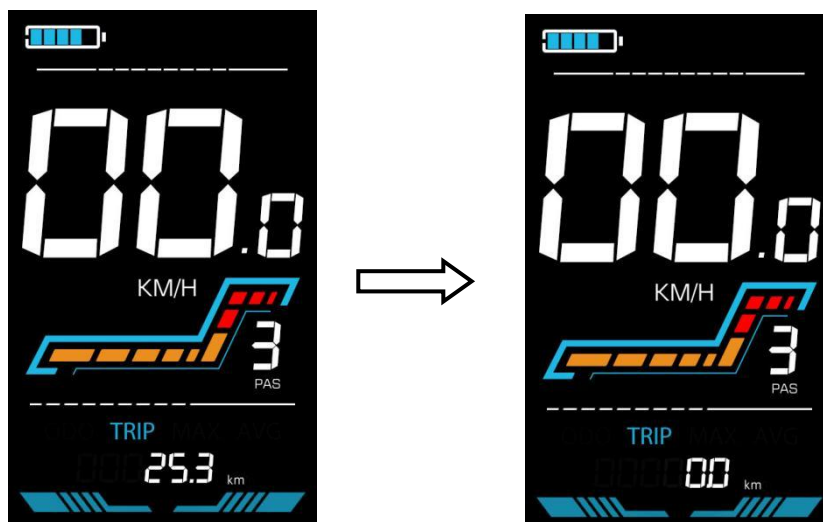

Figure 7-2 Trip Odometer Reset Interface

## 8. Quality Assurance and Warranty

### 8.1 Warranty info

● Yolin will offer a limited warranty for any failure caused by the product defects under normal use during the warranty period.

- The product is warranted for 12 months from the date out of factory.

### 8.2 Warranty does not cover

- The shell is opened.
- The connector is damaged.
- Scratches on the appearance after the product is out of factory.
- Scratched or broken wires
- Failure or damage caused by force majeure (e.g. fire, earthquake, etc.) or natural disaster (e.g. lightning strike, etc.)
- Out of warranty period.

## 9. Wire connection diagram

### 9.1 Standard wire connection sequence

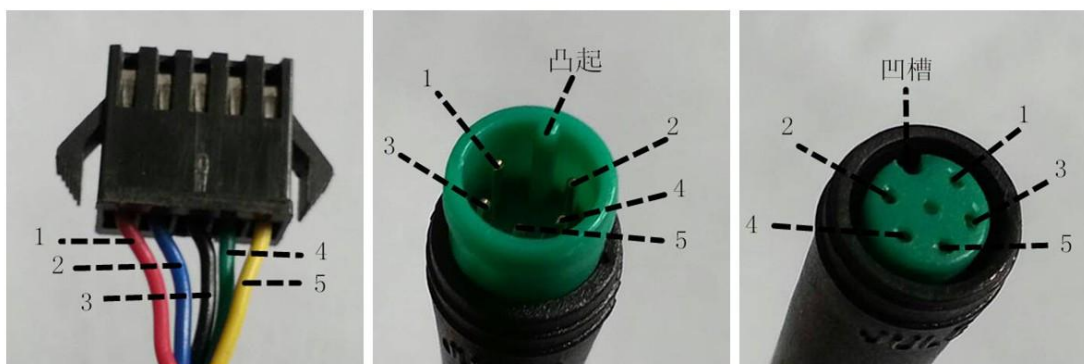

Controller connector

Display connector (Female terminal) Display connector (Male terminal)

Figure 9-1 Wire Connection Diagram

Table 9-1 Standard connector wire sequence table

Standard Wire Sequence	Standard wire color	Function
1	Red (VCC)	Display power wire
2	Blue (Kp)	Controller power wire
3	Black (GND)	Display ground wire
4	Green (RX)	Display data reception wire
5	Yellow (TX)	Display data transmit wire

■ Some models are equipped with waterproof connectors and the color inside wires can not be seen.

## 10. Precautions

Pay attention to all the general operating when using the products and do not plug and unplug the display while it is powered on.

- ◆ Avoid bumping the display as much as possible.
- ◆ Please do not change the parameter settings at will, otherwise normal riding cannot be guaranteed.
- ◆ If display does not work properly, please send it to the repair center as soon as possible.
- ◆ There may be differences between the physical products and this manual due to normal upgrade. Please refer to the physical products.

**Schedule 1: Error Code Definition**

YL-01, YL-02 Error codes			
Error code	Definition	Error code	Definition
E001	Controller failure	E004	Throttle failure
E002	Communication failure	E005	Brake failure
E003	Hall failure	E006	Motor phase failure
YL-05, KDS, YL-J Error codes			
Error code	Definition	Error code	Definition
E021	Current failure	E024	Hall failure
E022	Throttle failure	E025	Brake failure
E023	Motor phase failure	E030	Communication failure

**Schedule 2: Pedal assist level default ratio value**

Level Level selection	1	2	3	4	5	6	7	8	9
0-3/1-3	50%	74%	92%	-	-	-	-	-	-
0-5/ 1-5	50%	61%	73%	85%	96%	-	-	-	-
0-7/ 1-7	40%	50%	60%	70%	80%	90%	96%	-	-
0-9/ 1-9	25%	34%	43%	52%	61%	70%	79%	88%	96%

Tel: 022-86838795 Fax: 022-86838795

Email: yolin@yolintech.com

Website: www.yolintech.com

Address: Tianjin Beichen District, Tianjin Beichen Economic Development Zone, Medical Equipment Industrial Park, East of Jingfu Highway, Ugu New Science Park 52-1 plant